



Split-type Room Air Conditioner

Instruction Manual



AAS2009

AAS2012

AAS2018

AAS2024

Read this manual carefully and keep it for future reference.







This appliance is intended for domestic use only.

Contents

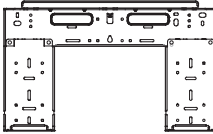
1 Safety Precautions	1
2 Parts Name and Function	3
3 Remote Controller Manual.....	4
4 Indoor Unit Installation	12
5 Outdoor Unit Installation	19
6 Refrigerant Piping Connection.....	23
7 Air Evacuation	27
8 Methods of Maintenance.....	29
9 Phenomenon Analysis and Treatment measures	30

Accessories

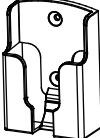
The air conditioning system comes with the following accessories. Use all of the installation parts and accessories to install the air conditioner. Improper installation may result in water leakage, electrical shock and fire, or cause the equipment to fail.

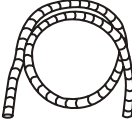
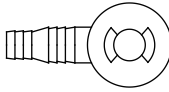
Name	Shape	Quantity
Mounting plate		1
Clip anchor		5
Mounting plate fixing screw ST3.9 X 25		5
Remote controller		1
Fixing screw for remote controller holder ST2.9 x 10		2
Remote controller holder		1
Dry battery (1.5V 7#)		2
Drain Pipe		1
Drain joint		1 (for cooling & heating models only)

1. Safety Precautions

Read Safety Precautions Before Installation

Incorrect installation due to ignoring instructions can cause serious damage or injury. The seriousness of potential damage or injuries is classified as either a WARNING or CAUTION.



Warning

This symbol indicates that ignoring instructions may cause death or serious injury.



Caution

This symbol indicates that ignoring instructions may cause moderate injury to your person, or damage to your appliance or other property.



Warning

This appliance can be used by children aged from 8 years and above and persons with reduced physical, sensory or mental capabilities or lack of experience and knowledge if they have been given supervision or instruction concerning use of the appliance in a safe way and understand the hazards involved. Children shall not play with the appliance. Cleaning and user maintenance shall not be made by children without supervision.

1. Installation Warnings

- Ask an authorized dealer to install this air conditioner. Inappropriate installation may cause water leakage, electric shock, or fire.
- All repairs, maintenance and relocation of the unit must be performed by an authorized service technician. Inappropriate repairs can lead to serious injury or product failure.

2. Warnings for product use

- If an abnormal situation arises (like a burning smell), immediately turn off the unit and pull the power plug. Call your dealer for instructions to avoid electric shock, fire or injury.
- Do not insert fingers, rods or other objects into the air inlet or outlet. This may cause injury, since the fan may be rotating at high speeds.
- Do not use flammable sprays such as hair spray, lacquer or paint near the unit. This may cause fire or combustion.
- Do not operate the air conditioner in places near or around combustible gases. Emitted gas may collect around the unit and cause explosion.
- Do not operate the air conditioner in a wet room (e.g., bath room or laundry room). This can cause electrical shock and cause the product to deteriorate.
- Do not expose your body directly to cool air for a prolonged period of time.

3. Electrical Warnings

- Only use the specified power cord. If the power cord is damaged, it must be replaced by the manufacturer or certified service agent.
- Keep power plug clean. Remove any dust or grime that accumulates on or around the plug. Dirty plugs can cause fire or electric shock.
- Do not pull power cord to unplug unit. Hold the plug firmly and pull it from the outlet. Pulling directly on the cord can damage it, which can lead to fire or electric shock.
- Do not use an extension cord, manually extend the power cord, or connect other appliances to the same outlet as the air conditioner. Poor electrical connections, poor insulation, and insufficient voltage can cause fire.

4. Cleaning and Maintenance Warnings

- Turn off the device and pull the plug before cleaning. Failure to do so can cause electrical shock.
- Do not clean the air conditioner with excessive amounts of water.
- Do not clean the air conditioner with combustible cleaning agents. Combustible cleaning agents can cause fire or deformation.



Caution

- If the air conditioner is used together with burners or other heating devices, thoroughly ventilate the room to avoid oxygen deficiency.
- Turn off the air conditioner and unplug the unit if you are not going to use it for a long time.
- Turn off and unplug the unit during storms.
- Make sure that water condensation can drain unhindered from the unit.
- Do not operate the air conditioner with wet hands. This may cause electric shock.
- Do not use device for any other purpose than its intended use.
- Do not climb onto or place objects on top of the outdoor unit.
- Do not allow the air conditioner to operate for long periods of time with doors or windows open, or if the humidity is very high.



Dispose of packaging in an environmentally-friendly manner.

This appliance is labelled in accordance with European Directive 2012/19/EU concerning used electrical and electronic appliances (waste electrical and electronic equipment - WEEE). The guideline determines the framework for the return and recycling of used appliances as applicable throughout the EU.

PACKAGE INFORMATION: Packaging materials of the product are manufactured from recyclable materials in accordance with our National Environment Regulations. Do not dispose of the packaging materials together with the domestic or other wastes. Take them to the packaging material collection points designated by the local authorities.

2. Parts Name and Function

Because there are many models, features and appearance will vary, we only introduce the follow pattern, others please refer to using.

Indoor unit

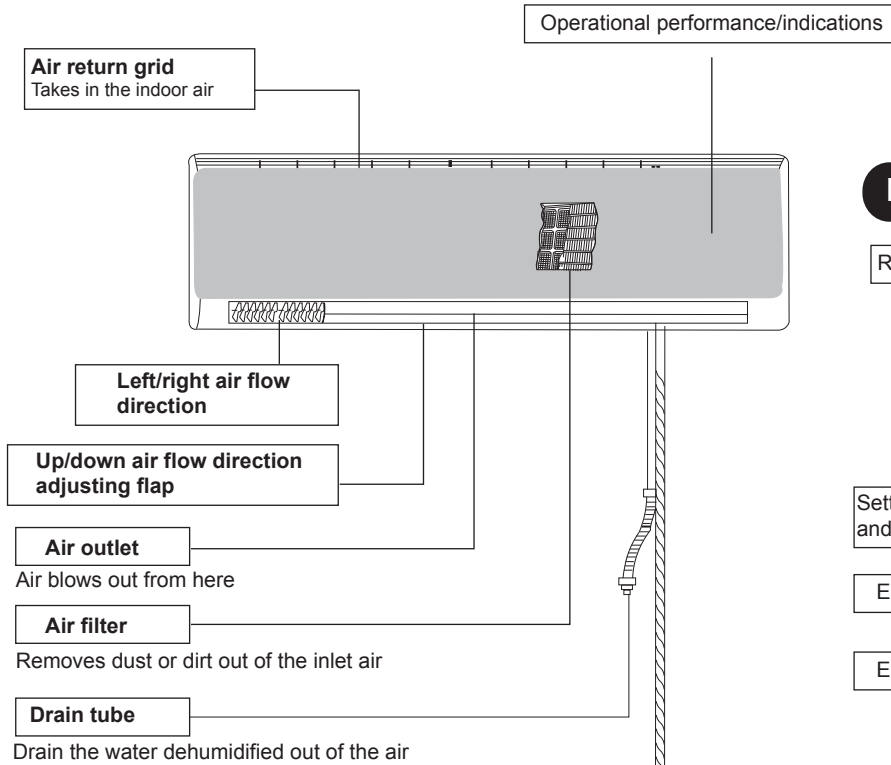

Indications of unit 1

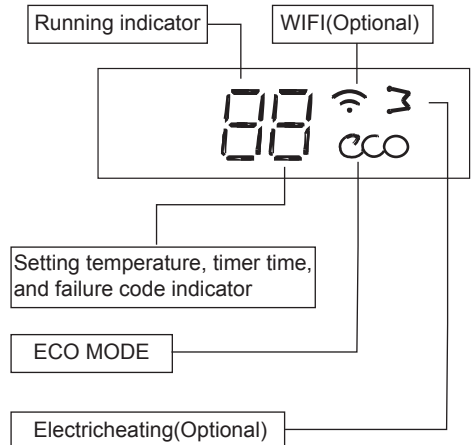

Outdoor unit

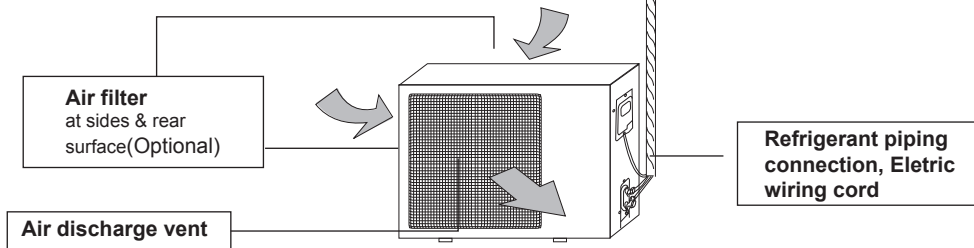

Unit operation section

How to open

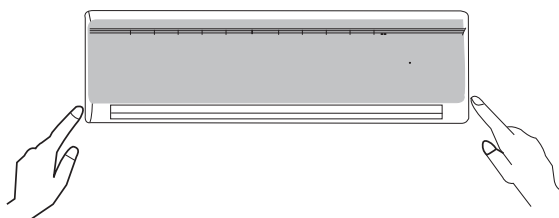

How to close

Push down the air inlet grid and then push both sides of air inlet grid at the bottom

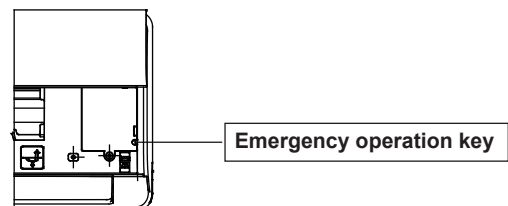

Note: Do not open the grid at an angle over 60 degrees. Do not operate the units with too much force.

3. Remote Controller Manual







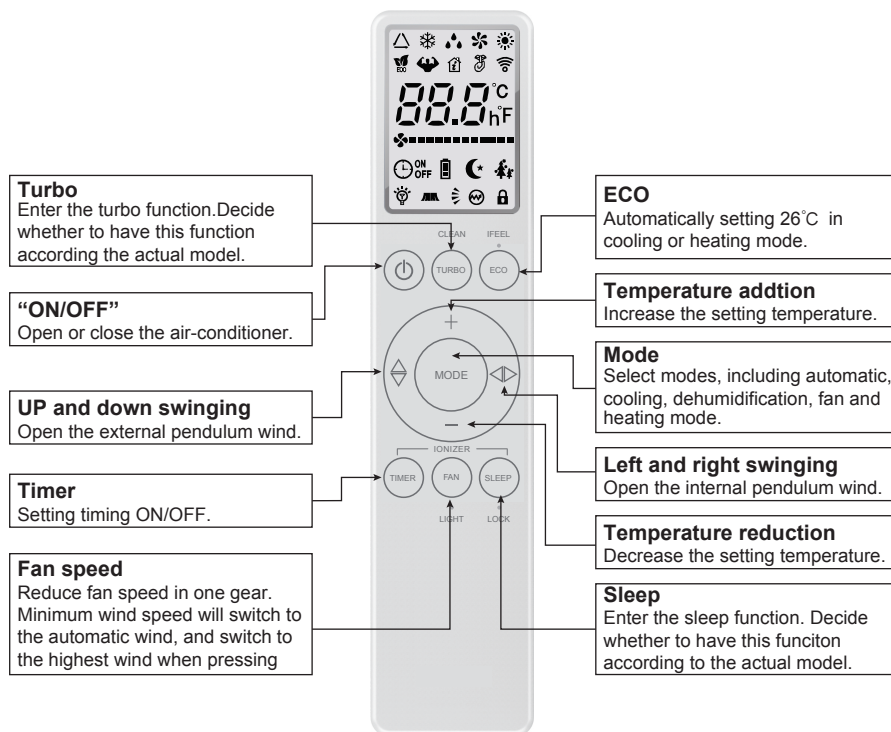





! Caution

- Do not place remote controller near heat sources such as electric blankets or heating furnaces.
- Do not place remote controller in direct sunlight.
- Be careful not to drop, otherwise it may cause damage.
- No obstacle between the signal receiver and the remote controller, so as not to affect the transmission and reception of the signal.
- Point the remote controller to the air conditioner, press the button on the remote controller, and send the command signal to the air conditioner.
- If the signal is received correctly, the air conditioner will issue a "beep" prompt.
- If the remote controller is not available, please replace the new battery and try again. But if the problem persists, please contact the seller or our authorized service center.
- The following two kinds of remote controllers is model 1 and model 2, will add another new remote controllers.

3.2 Instructions of remot controller model 1



1. The icon meaning of remote controller model 1

- 1) The remote controller is equipped with 11 buttons, and the LCD is newly made.
- 2) At the first power on, the LCD of the remote controller displays all the icons first and then enters the standby state, displaying only the mode icon.
- 3) Introduction of LCD screen icon:
 - Mode display: automatic , cooling , dehumidification , fan  and heating .
 - Temperature display:  displays temperature, which range between 16~32°C or 61~90°F.
 - Wind speed display:  means wind speed.
 - Swinging display:  means external pendulum wind.  means internal pendulum wind.
 - Timer display:  means TIMEON.  means TIMEOFF.
 - Other display:  means sleep;  means TURBO; means ECO; means electric heating;
 - means lock; means lamplight.

3. Remote Controller Manual

2. Button function of remote controller model 1

ON/OFF :

1) When pressing this key, the remote controller switches by "on, off, on" circularly.

Mode :

1) When pressing this key, the remote controller switches by "automatic, cooling, dehumidification, fan, heating, automatic" circularly.

2) In dehumidification mode, the setting temperature of the internal machine is 25 degree C. The remote controller does not display the setting temperature and is not adjustable. The internal pendulum wind stays unchanged according to the state before switching, but the external pendulum wind is forced to close.

Temperature reduction-

1) Temperature setting: when pressing this key, the setting temperature will be reduced by "32°C, 31°C,, 17°C, 16°C". (When pressing this key in dehumidification and fan mode, the temperature will not change).

2) Keep pressing will continuously change the temperature.

Temperature addition+

1) Temperature setting: when pressing this key, the setting temperature will be added by "16°C, 17°C,, 31°C, 32°C". (When pressing this key in dehumidification and fan mode, the temperature will not change).

2) Keep pressing will continuously change the temperature.

Up and down swinging (External pendulum wind)

1) Pressing this key in the dehumidification mode, the external pendulum wind is forced to close.

2) Pressing this key in the other modes, the external pendulum switches by "swing, fixed wind, swing" circularly.

Left and right swinging (Internal pendulum wind):

1) Pressing this key in the dehumidification mode, the internal pendulum wind stays unchanged according to the state before switching.

2) Pressing this key in the other modes, the internal pendulum switches by "swing, stop, swing" circularly.

FAN:

1) When the first power on, the remote controller is set to the automatic wind speed by default. In dehumidification mode, the wind speed is fixed to low wind and is not adjustable. By pressing the wind speed key, there is no response to the remote controller.

2) Pressing this key in the other modes, the wind speed switches by "automatic wind speed, low speed, middle speed, high speed, automatic wind speed" circularly. pendulum switches by "swing, stop, swing" circularly. high speed, automatic wind speed" circularly.

Timer:

1) Under the shutdown state, press this key to set the opening time, range from 1 hour to 24 hour.

2) Under the boot state, press this key to set the shutdown time, range from 1 hour to 24 hour.

3) The timing time is according to the cycle of "1h, 2h,, 23h, 24h, cancel, 1h".

4) Exit timing adjustment after 3 seconds without key pressing.

TURBO:

1) Extension code remote controller has the effect. The remote controller is no TURBO by default, and the TURBO key will not work in automatic mode, dehumidification mode and fan mode.

2) Pressing this key in the cooling or heating mode, the TURBO mode switches between opening and closing. When in the TURBO mode, it still displays the wind speed. Switching mode or entering sleep function will close TURBO mode.

3) If the air conditioner has TURBO mode, pressing this key, the remote controller still displays current wind speed, and indoor unit runs with the highest wind.

ECO:

1) The remote controller is no ECO by default, and the ECO key will not work in automatic mode, dehumidification mode and fan mode.

2) Pressing this key in the cooling or heating mode, the ECO mode switches between opening and closing. When in the ECO mode, the setting temperature is set to 26°C(79°F) and other settings are unchanged. If closing ECO mode, the remote controller will recover to the setting before opening ECO mode. Switching mode will close ECO mode.

SLEEP:

1) Pressing this key in the modes except of the fan mode, the sleep function switches between opening and closing. Switching mode will cancel sleep function.

2) When pressing this key, the wind speed is automatically switched to low wind. However, the wind speed can be adjusted according to the wind speed key (except of the dehumidification mode).

LIGHT

3. Remote Controller Manual

- 1) When the first power on, there is no lamplight by default. Pressing Fan key 3S force to turn off or turn on the lamplight. Decide whether to have this function according to the actual model.

LOCK

- 1) There is no lock by default. Pressing Sleep key 3S, the lock function switches between opening and closing.

Electricheating(Optional)

- 1) Pressing Timer key 3S, the electric heating function switches between opening and closing.
- 2) It only works in heating mode, switch heating mode, the default on.

CLAEN(Optional)

- 1) The remote controller is no CLEAN by default. Pressing TURBO key 3S, the CLEAN function switches between opening and closing. Decide whether to have this function according to the actual model.

IFEEL(Optional)

- 1) The remote controller is no IFEL by default. Pressing ECO key 3S, the IFEEL function switches between opening and closing. Decide whether to have this function according to the actual model.

Distribution function

- 1) Press the TURBO 10 times or more continuously within 20 seconds until the lamplight displays A P. Decide whether to have this function according to the actual model.

Combinatorial key: "Mode +ECO"

- 1) On the shutdown interface, press the combinatorial key on the remote controller for 5 seconds to enter the address setting interface, the address displayed by the remote controller after entering is the address retained last time. When controlling the wired controller by remote controller, press the mode key to query the address, querying address remote controller interface does not display, the wired controller can display.
- 2) At the address setting interface, press the temperature addition or reduction to adjust the setting address, and it ranges from 00 → 1 → ... → 99 → 00. Press the ON / OFF key to enter the sending state and send the address setting code.
- 3) Press the combinatorial key on the remote controller for 5 seconds to exit the address setting interface. If there is no key pressing associated with address setting for more than 30 minutes, the remote controller will exit the address setting interface.

Combinatorial key: "TIMER" + "SLEEP"(Optional)

- 1) Pressing the combinatorial key on the remote controller for 3 seconds, the ionizer function switches between opening and closing.
- 2) The ionizer function works in any mode. When the ionizer function is ON, if turn off the unit, the ionizer function will be closed at same time and it is still closed after turning on the unit again.

3. Remote Controller Manual



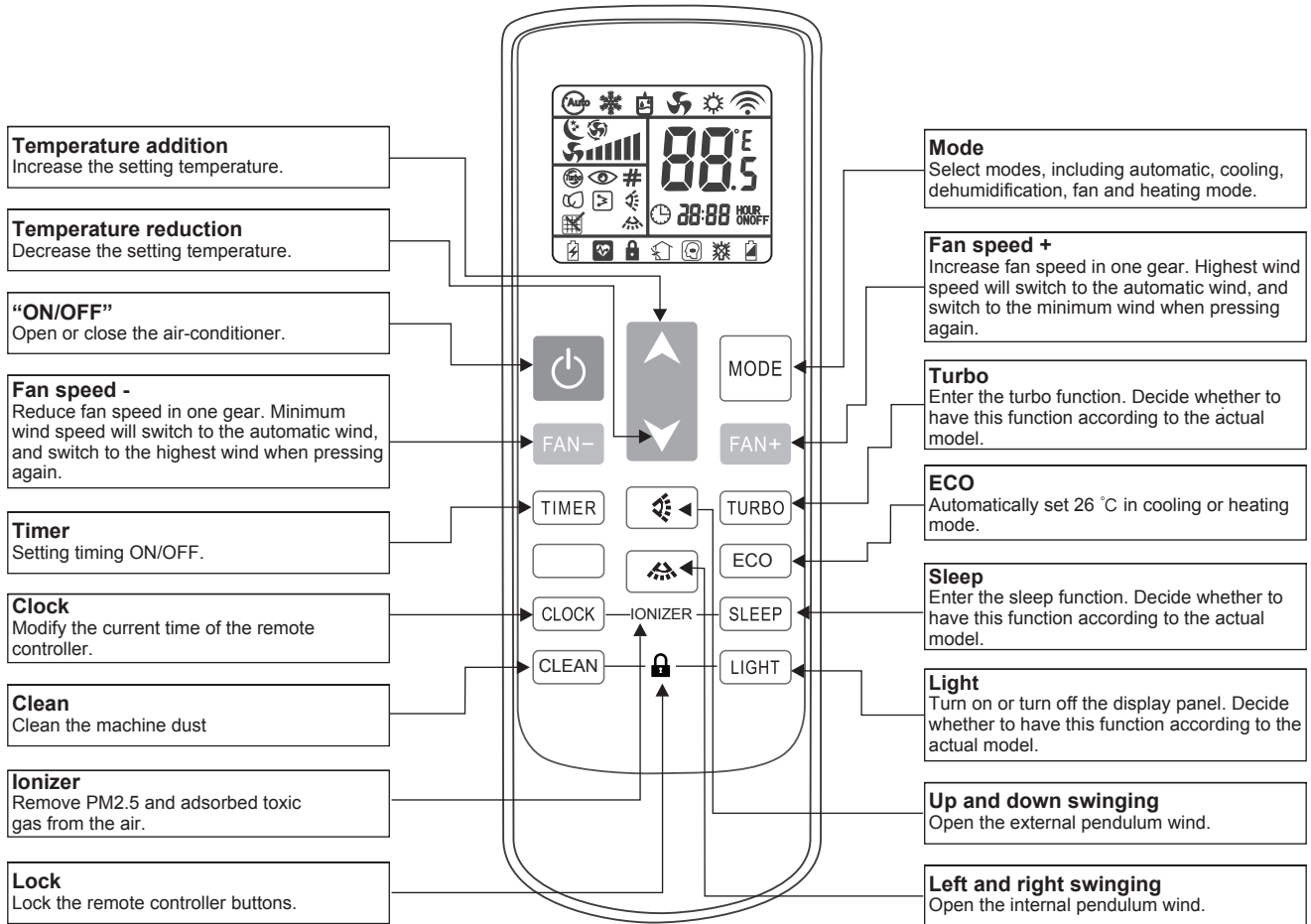





















3.2 Instructions of remote controller model 2



1. The icon meaning of remote controller model 1



3. Remote Controller Manual

- 1) The remote controller is equipped with 15 buttons, and the LCD is newly made. All the icons are kept in touch with the touch-screen remote controller.
- 2) At the first power on, the LCD of the remote controller displays all the icons first and then enters the standby state, displaying only the clock 12:00 and the light icon.
- 3) Introduction of LCD screen icon:
 - Mode display: automatic 、cooling 、dehumidification 、fan and heating .
 - Temperature display:  displays temperature, which range between 16 ~ 32°C or 61 ~ 90 °F .
 - Wind speed display:  means wind speed.  means automatic wind speed.
 - Swinging display:  means external pendulum wind.  means internal pendulum wind.
 - Timer display:  means TIME ON.  means TIME OFF.
 - Other display:  means clock.  means sleep.  means TURBO.  means ECON.  means cleaning.  means electric heating.  means address.  means lock.  means lack of electricity.
 - Reserved function:  means Auto Config.  means power saving.  means ionizer.  means new wind.  means intelligence.  means lamp light.

2. Button function of remote controller model 2

ON/OFF

- 1) When pressing this key, the remote controller switches by "on, off, on" circularly.
- 2) When the first power on, the working state is set by default: setting temperature 25°C (77°F), automatic mode, automatic fan speed, internal and external pendulum wind, no TURBO, no sleep, no timer, no lock).
- 3) When the power on is not the first time, the state before shutdown is recovered. After shutdown, the sleep, TURBO, ECO and timer functions will be canceled.

Mode

- 1) When pressing this key, the remote controller switches by "automatic, cooling, dehumidification, fan, heating, automatic" circularly.
- 2) The dehumidification mode is locked at 25°C and the temperature can not be adjusted. The internal pendulum wind stays unchanged according to the state before switching, but the external pendulum wind is forced to close.

Temperature reduction ▼

- 1) Temperature setting: when pressing this key, the setting temperature will be reduced by 1. The temperature of centigrade model will be reduced progressively by "32°C, 31°C,, 17°C, 16°C". The temperature of fahrenheit model will be reduced progressively by "90°F, 89°F,, 62°F, 61°F". When pressing this key in dehumidification and fan mode, the temperature will not change.
- 2) In the clock setting state (the clock icon flashes), this key is used to set the clock time.
- 3) Keep pressing will continuously change the temperature.

Temperature addition ▲

- 1) Temperature setting: when pressing this key, the setting temperature will be added by 1. The temperature of centigrade model will be added progressively by "16°C, 17°C,, 31°C, 32°C, The temperature of fahrenheit model will be added progressively by "61°F, 62°F,, 89°F, 90°F". When pressing this key in dehumidification and fan mode, the temperature will not change.
- 2) In the clock setting state (the clock icon flashes), this key is used to set the clock time.
- 3) Keep pressing will continuously change the temperature.

Up and down swinging (External pendulum wind)

- 1) Pressing this key in the dehumidification mode doesn't work. The external pendulum wind is forced to close.
- 2) Pressing this key in the other modes, the external pendulum switches by "swing, fixed wind, swing" circularly.

Left and right swinging (Internal pendulum wind)

- 1) Pressing this key in the dehumidification mode, the internal pendulum wind stays unchanged according to the state before switching.
- 2) Pressing this key in the other modes, the internal pendulum switches by "swing, stop, swing" circularly.

"FAN -"

- 1) When the first power on, the remote controller is set to the automatic fan speed by default. In dehumidification mode, the fan speed is fixed to low speed and is not adjustable. By pressing the wind speed key, there is no response to the remote controller.

3. Remote Controller Manual

- 2) Pressing this key in the other modes, the wind speed switches by "automatic wind speed, high speed, middle speed, low speed, automatic wind speed " circularly.

“FAN +”

- 1) When the first power on, the remote controller is set to the automatic wind speed by default. In dehumidification mode, the fan speed is fixed to low speed and is not adjustable. By pressing the fan speed key, there is no response to the remote controller.
- 2) Pressing this key in the other modes, the fan speed switches by "automatic fan speed, low speed, middle speed, high speed, automatic wind speed " circularly.

Timer

- 1) Under the shutdown state, press this key to set the opening time, range from 1 hour to 24 hours.
- 2) Under the running state, press this key to set the shutdown time, range from 1 hour to 24 hours.
- 3) The timing time is according to the cycle of "1h, 2h,, 23h, 24h, cancel, 1h".
- 4) Exit timing adjustment after 3 seconds without key pressing.

TURBO

- 1) Extension code remote controller has the effect. The remote controller is no TURBO by default, and the TURBO key will not work in automatic mode, dehumidification mode and fan mode.
- 2) Pressing this key in the cooling or heating mode, the TURBO mode switches between opening and closing. When in the TURBO mode, it does not display the fan speed. Switching mode or entering sleep function will close TURBO mode.
- 3) If the air conditioner has four gear fan speeds, the TURBO icon will light up and the fan will run in the fourth gear wind speed by pressing this key.

ECO

- 1) The ECO key will not work in automatic mode, dehumidification mode and fan mode.
- 2) Pressing this key in the cooling or heating mode, the ECO mode switches between opening and closing. When in the ECO mode, the setting temperature is set to 26°C (77°F) and other settings are unchanged. If closing ECO mode, the remote controller will recover to the setting before opening ECO mode. Switching mode will close ECO mode.

Sleep

- 1) Pressing this key in the modes except of the fan mode, the sleep function switches between opening and closing. Switching mode will cancel sleep function.
- 2) When pressing this key, the fan speed is automatically switched to low wind. However, the wind speed can be adjusted according to the fan speed key (except of the dehumidification mode).

Light

- 1) When the first power on, there is no lamplight by default. Pressing this key force to turn off or turn on the lamplight manually. Decide whether to have this function according to the actual model.

Clock

- 1) This key is used to set the clock. Pressing enters the hour adjustment state, and the hour digital tube on the LCD is flickering at the same time. The hour can be set by temperature addition or reduction keys, and it ranges from 0 to 23.
- 2) When the hour is set, press this key again to enter the minute adjustment state, and the minute digital tube on the LCD is flickering at the same time. The minute can be set by temperature addition or reduction keys, and it ranges from 00 to 59.
- 3) After adjusting, press the clock key again to confirm the setting and the adjustment state exits. If do not press the clock key again to confirm, the time adjustment state will exit after 3 seconds, and recover the clock before the adjustment.

Clean

- 1) The remote controller is no CLEAN by default. Pressing TURBO key 3S, the CLEAN function switches between opening and closing. Decide whether to have this function according to the actual function

Combinatorial key: “CLOCK” + “SLEEP”

- 1) Pressing the combinatorial key on the remote controller for 3 seconds, the ionizer function switches between opening and closing.
- 2) The ionizer function works in any mode. When the ionizer function is ON, if turn off the unit, the ionizer function will be closed at same time and it is still closed after turning on the unit again.

Combinatorial key: “CLEAN” + “LIGHT”

- 1) Pressing the combinatorial key on the remote controller for 3 seconds ,the lock function switches between opening and closing.

3. Remote Controller Manual

2) When it is locked, the remote controller does not work except the lock key.

Combinatorial key: "Mode" + "CLEAN" + "LIGHT"

1) Enter address setting

- a. On the shutdown interface, press the combinatorial key on the remote controller for 5 seconds to enter the address setting interface.
- b. The last address (when the first power on, 00 is displayed) and the "#" icon are displayed and flickering.

2) The step instructions of setting address

- a. At the address setting interface, press the temperature addition or reduction to adjust the setting address, and it ranges from 00 to 99
- b. When the first time entering the interface or pressing the temperature addition or reduction key, the address display flickers for 3 seconds and then does not flicker.
- c. Press the ON / OFF key to enter the sending state and send the address setting code.

3) The step instructions of inquiring address

- a. At the address setting interface, press the mode key to send the query code.
- b. At this time, the "#" icon flickers. 3 seconds later, it normally displays the last setting addresses and the "#" icon does not flicker.

4) Exit setting

- a. Pressing the combinatorial key key at the same time can exit the address setting interface.
- b. If there is no key pressing associated with address setting for more than 30 minutes, the remote controller will exit the address setting interface.

3.3 Battery replacement

1. If the air conditioner is unable to receive the signal from the wire controller, or the LCD of wire controller is blurred, it means that the battery is depleted and needs to be replaced.
2. Take off the back cover and remove the old batteries. When replacing batteries, please pay attention to the "+" and "-" marking on the battery.
3. Install the back cover and set the current time.

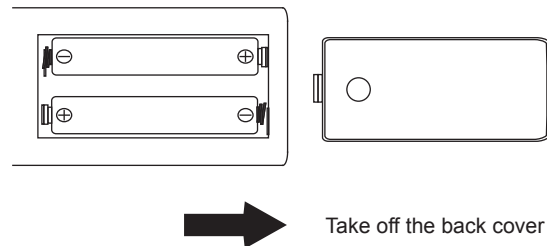

Caution

- Do not mix old and new batteries together.
- When the wire controller is idle for a long time, the battery should be removed.
- In general, the service life of a dry battery that meets the JIS or IEC standards can be up to 6-12 months, but if it exceeds the use time or not in conformity with above specifications, the dry battery may leak and may even cause the wire controller operation to be invalid.
- The recommended service life is marked on the battery, but the actual service life may be shorter.

4. Indoor Unit Installation

Refer to Fig4.1 to ensure proper distance from walls and ceiling:

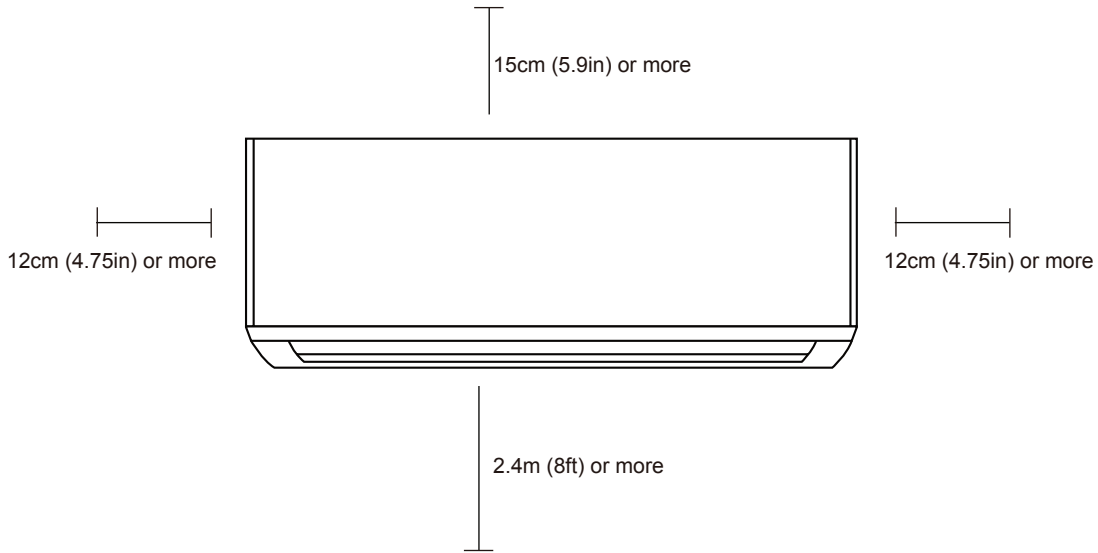

Fig. 4.1

4.1 Attach mounting plate to wall

The mounting plate is the device on which you will mount the indoor unit.

1. Remove the screw that attaches the mounting plate to the back of the indoor unit.
2. Place the mounting plate against the wall in a location that meets the standards in the Select Installation Location step. (Mounting Plate Dimensions as the following Fig.4.2)
3. Drill holes for mounting screws in places that:
 - 1) have studs and can support the weight of the unit.
 - 2) correspond to screw holes in the mounting
4. Secure the mounting plate to the wall with the screws provided.
5. Make sure that mounting plate is flat against the wall.

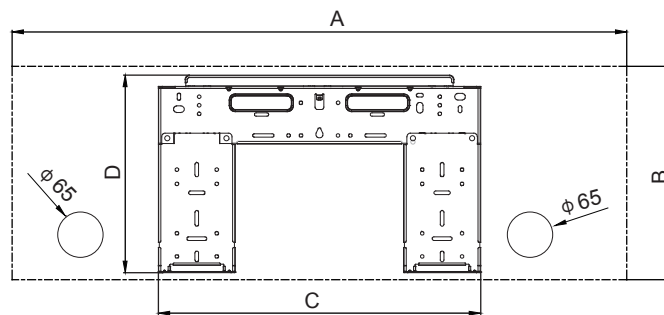

Fig. 4.2

Unit: (mm)

Model(KBth/h) \ tems	A	B	C	D
09	715	298	396	272
12	865	300	453	277
18/24	972	320	619	294

4.2 Drill wall hole for connective piping

Note for Concrete or Brick Walls:

If the wall is made of brick, concrete, or similar material, drill 5mm-diameter (0.2in-diameter) holes in the wall and insert the sleeve anchors provided. Then secure the mounting plate to the wall by tightening the screws directly into the clip anchors.

4. Indoor Unit Installation

You must drill a hole in the wall for refrigerant piping, the drainage pipe, and the signal cable that will connect the indoor and outdoor units.

1. Determine the location of the wall hole based on the position of the mounting plate. Refer to above Mounting Plate Dimensions to help you determine the optimal position. The wall hole should have a 65mm(2.5in) diameter at least, and at a slightly lower angle to facilitate drainage.
2. Using a 65mm (2.5in) or 90mm(3.54in) (depending on models)core drill, drill a hole in the wall. Make sure that the hole is drilled at a slight downward angle, so that the outdoor end of the hole is lower than the indoor end by about 5mm to 7mm (0.2-0.27in). This will ensure proper water drainage. (See Fig. 4.3)
3. Place the protective wall cuff in the hole. This protects the edges of the hole and will help seal it when you finish the installation process.

! Caution

When drilling the wall hole, make sure to avoid wires, plumbing, and other sensitive components.

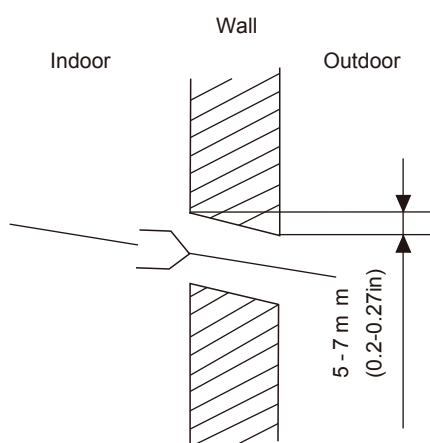

Fig. 4.3

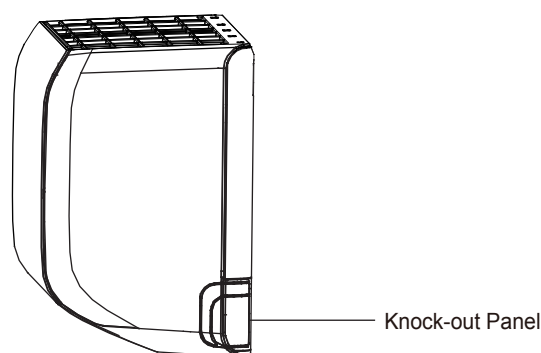

Fig. 4.4

4.3 Prepare refrigerant piping

The refrigerant piping is inside an insulating sleeve attached to the back of the unit. You must prepare the piping before passing it through the hole in the wall. Refer to the Refrigerant Piping Connection section of this manual for detailed instructions on pipe flaring and flare torque requirements, technique, etc.

1. Based on the position of the wall hole relative to the mounting plate, choose the side from which the piping will exit the unit.
2. If the wall hole is behind the unit, keep the knock-out panel in place. If the wall hole is to the side of the indoor unit, remove the plastic knock-out panel from that side of the unit. (See Fig. 4.4). This will create a slot through which your piping can exit the unit. Use needle nose pliers if the plastic panel is too difficult to remove by hand.
3. Use scissors to cut down the length of the insulating sleeve to reveal about 15cm (6in) of the refrigerant piping. This serves two purposes:
 - 1) To facilitate the Refrigerant Piping Connection process
 - 2) To facilitate Gas Leak Checks and enable you to check for dents
4. If existing connective piping is already embedded in the wall, proceed directly to the Connect Drain Hose step. If there is no embedded piping, connect the indoor unit's refrigerant piping to the connective piping that will join the indoor and outdoor units. Refer to the Refrigerant Piping Connection section of this manual for detailed instructions.
5. Based on the position of the wall hole relative to the mounting plate, determine the necessary angle of your piping.
6. Grip the refrigerant piping at the base of the bend.
7. Slowly, with even pressure, bend the piping towards the hole. Do not dent or damage the piping during the process.

4. Indoor Unit Installation

Note on piping angle:

Refrigerant piping can exit the indoor unit from four different angles (Refer to Fig 4.5 for details):

- a. Left-hand side b. Left rear c. Right-hand side d. Right rear

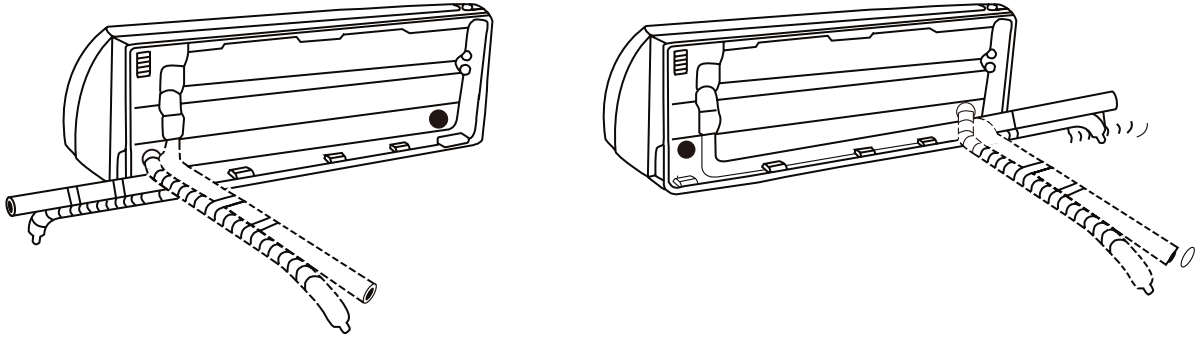

Fig. 4.5



Caution

Be extremely careful not to dent or damage the piping while bending them away from the unit. Any dents in the piping will affect the unit's performance.

4.4 Connect drain hose

By default, the drain hose is attached to the left-hand side of unit (when you're facing the back of the unit). However, it can also be attached to the right-hand side.

1. To ensure proper drainage, attach the drain hose on the same side that your refrigerant piping exits the unit.
2. Attach drain hose extension (purchased separately) to the end of drain hose.
3. Wrap the connection point firmly with Teflon tape to ensure a good seal and to prevent leaks.
4. For the portion of the drain hose that will remain indoors, wrap it with foam pipe insulation to prevent condensation.
5. Remove the air filter and pour a small amount of water into the drain pan to make sure that water flows from the unit smoothly.



Caution

Make sure to arrange the drain hose according to Fig 4.6.

- Do not kink the drain hose.
- Do not create a water trap.
- Do not put the end of drain hose in water or a container that will collect water.

Plug the unused drain hole

To prevent unwanted leaks you must plug the unused drain hole with the rubber plug provided.

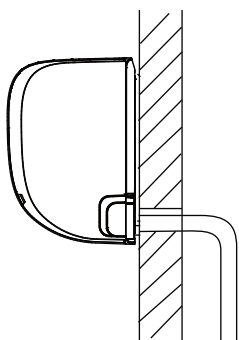
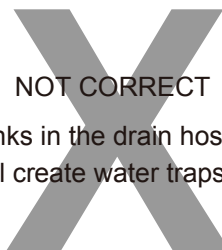

Fig. 4.6

CORRECT

Make sure there are no kinks or dent in drain hose to ensure proper drainage.



NOT CORRECT

Kinks in the drain hose will create water traps.

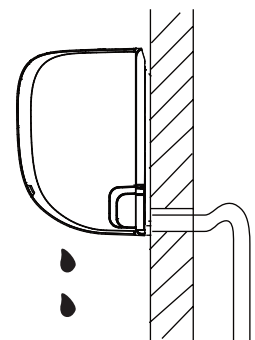

Fig. 4.7

4. Indoor Unit Installation

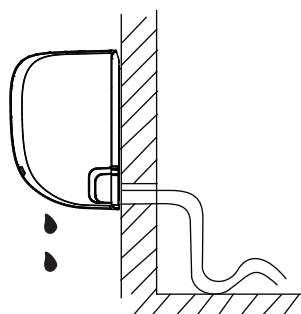

Fig. 4.8

NOT CORRECT
Kinks in the drain hose will create water traps.

NOT CORRECT
Do not place the end of the drain hose in water or in containers that collect water. This will prevent proper drainage.

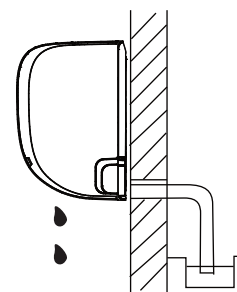

Fig. 4.9

4.5 Connect signal cable

Before performing electrical work, read these regulations

- All wiring must comply with local and national electrical codes, and must be installed by a licensed electrician.
- All electrical connections must be made according to the Electrical Connection Diagram located on the panels of the indoor and outdoor units.
- If there is a serious safety issue with the power supply, stop work immediately. Explain your reasoning to the client, and refuse to install the unit until the safety issue is properly resolved.
- Power voltage should be within 90-110% of rated voltage. Insufficient power supply can cause malfunction, electrical shock, or fire.
- If connecting power to fixed wiring, install a surge protector and main power switch with a capacity of 1.5 times the maximum current of the unit.
- If connecting power to fixed wiring, a switch or circuit breaker that disconnects all poles and has a contact separation of at least 1/8in (3mm) must be incorporated in the fixed wiring. The qualified technician must use an approved circuit breaker or switch.
- Only connect the unit to an individual branch circuit outlet. Do not connect another appliance to that outlet.
- Make sure to properly ground the air conditioner.
- Every wire must be firmly connected. Loose wiring can cause the terminal to overheat, resulting in product malfunction and possible fire.
- Do not let wires touch or rest against refrigerant tubing, the compressor, or any moving parts with the unit.
- If the unit has an auxiliary electric heater, it must be installed at least 1 meter (40in) away from any combustible materials.

Warning

Before performing any electrical or wiring work, turn off the main power to the system.

The signal cable enables communication between the indoor and outdoor units. You must first choose the right cable size before preparing it for connection.

Cable Types

- 1) Indoor Power Cable (if applicable): H05VV-F or H05V2V2-F
- 2) Outdoor Power Cable: H07RN-F
- 3) Signal Cable: H07RN-F

Minimum Cross-Sectional Area of Power and Signal Cables

Rated Current of Appliance (A)	Nominal Cross-Sectional Area (mm ²)
> 3 and ≤ 6	0.75
> 6 and ≤ 10	1
> 10 and ≤ 16	1.5
> 16 and ≤ 25	2.5
> 25 and ≤ 32	4
> 32 and ≤ 40	6

4. Indoor Unit Installation

Note:

- The size of the power supply cable, signal cable, fuse, and switch needed is determined by the maximum current of the unit. The maximum current is indicated on the nameplate located on the side panel of the unit. Refer to this nameplate to choose the right cable, fuse, or switch.
- The air conditioner's circuit board (PCB) is designed with a fuse to provide overcurrent protection. The specifications of the fuse are printed on the circuit board, such as: T3.15A/250VAC, T5A/250VAC, etc.

1. Prepare the cable for connection:

- a. Using wire strippers, strip the rubber jacket from both ends of signal cable to reveal about 40mm (1.57in) of the wires inside.
- b. Strip the insulation from the ends of the wires.
- c. Using wire crimper, crimp u-type lugs on the ends of the wires.

Note: While crimping wires, make sure you clearly distinguish the Live ("L") Wire from other wires.

2. Open front panel of the indoor unit.

3. Using a screwdriver, open the wire box cover on the right side of the unit. This will reveal the terminal block.

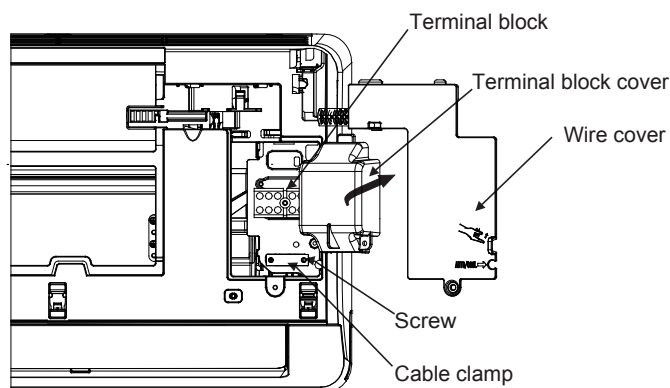

Fig. 4.10



Warning

All wiring must be performed strictly in accordance with the wiring diagram located on the inside of the indoor unit's wire cover.

4. Unscrew the cable clamp below the terminal block and place it to the side.
5. Facing the back of the unit, remove the plastic panel on the bottom left-hand side.
6. Feed the signal wire through this slot, from the back of the unit to the front.
7. Facing the front of the unit, match the wire colors with the labels on the terminal block, connect the u-lug and firmly screw each wire to its corresponding terminal.



Caution

Do not mix up live and null wires!

This is dangerous, and can cause the air conditioning unit to malfunction.

8. After checking to make sure every connection is secure, use the cable clamp to fasten the signal cable to the unit. Screw the cable clamp down tightly.
9. Replace the wire cover on the front of the unit, and the plastic panel on the back.

Note: The wiring connection process may differ slightly between units.

4. Indoor Unit Installation

4.6 Wrap piping and cables

Before passing the piping, drain hose, and the signal cable through the wall hole, you must bundle them together to save space, protect them, and insulate them.

1. Bundle the drain hose, refrigerant pipes, and signal cable according to Fig. 4.11.

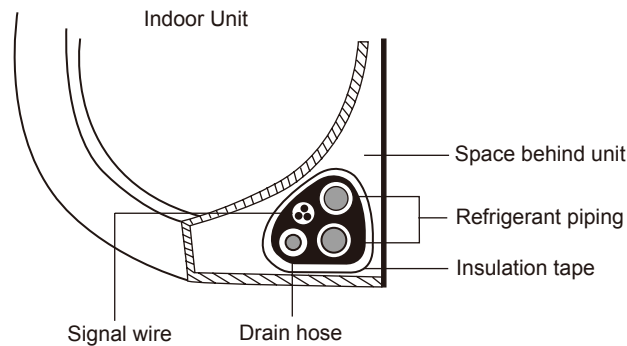

Fig. 4.11

Note:

- **Drain hose must be on bottom**

Make sure that the drain hose is at the bottom of the bundle. Putting the drain hose at the top of the bundle can cause the drain pan to overflow, which can lead to fire or water damage.

- **Do not intertwine signal cable with other wires**

While bundling these items together, do not intertwine or cross the signal cable with any other wiring.

2. Using adhesive vinyl tape, attach the drain hose to the underside of the refrigerant pipes.
3. Using insulation tape, wrap the signal wire, refrigerant pipes, and drain hose tightly together. Double-check that all items are bundled in accordance with Fig. 4.11.

Note:

- **Do not wrap ends of piping**

When wrapping the bundle, keep the ends of the piping unwrapped. You need to access them to test for leaks at the end of the installation process (refer to Electrical Checks and Leak Checks section of this manual).

4.7 Mount indoor unit

If you installed new connective piping to the outdoor unit, do the following:

1. If you have already passed the refrigerant piping through the hole in the wall, proceed to Step 4.
2. Otherwise, double-check that the ends of the refrigerant pipes are sealed to prevent dirt or foreign materials from entering the pipes.
3. Slowly pass the wrapped bundle of refrigerant pipes, drain hose, and signal wire through the hole in the wall.
4. Hook the top of the indoor unit on the upper hook of the mounting plate.
5. Check that unit is hooked firmly on mounting by applying slight pressure to the left and right-hand sides of the unit. The unit should not jiggle or shift.
6. Using even pressure, push down on the bottom half of the unit. Keep pushing down until the unit snaps onto the hooks along the bottom of the mounting plate.
7. Again, check that the unit is firmly mounted by applying slight pressure to the left and the right-hand sides of the unit.

4. Indoor Unit Installation

If refrigerant piping is already embedded in the wall, do the following:

1. Hook the top of the indoor unit on the upper hook of the mounting plate.
2. Use a bracket or wedge to prop up the unit, giving you enough room to connect the refrigerant piping, signal cable, and drain hose. Refer to Fig. 4.12 for an example.

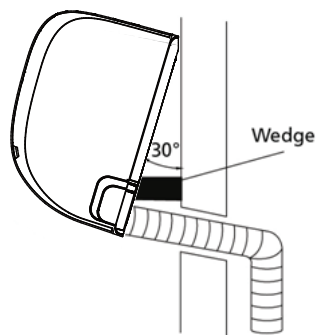

Fig. 4.12

3. Connect drain hose and refrigerant piping (refer to Refrigerant Piping Connection section of this manual for instructions).
4. Keep pipe connection point exposed to perform the leak test (refer to Electrical Checks and Leak Checks section of this manual).
5. After the leak test, wrap the connection point with insulation tape.
6. Remove the bracket or wedge that is propping up the unit.
7. Using even pressure, push down on the bottom half of the unit. Keep pushing down until the unit snaps onto the hooks along the bottom of the mounting plate.

Note:

• **Unit is adjustable**

Keep in mind that the hooks on the mounting plate are smaller than the holes on the back of the unit. If you find that you don't have ample room to connect embedded pipes to the indoor unit, the unit can be adjusted left or right by about 30-50mm (1.25-1.95in), depending on the model. (See Fig. 4.13)

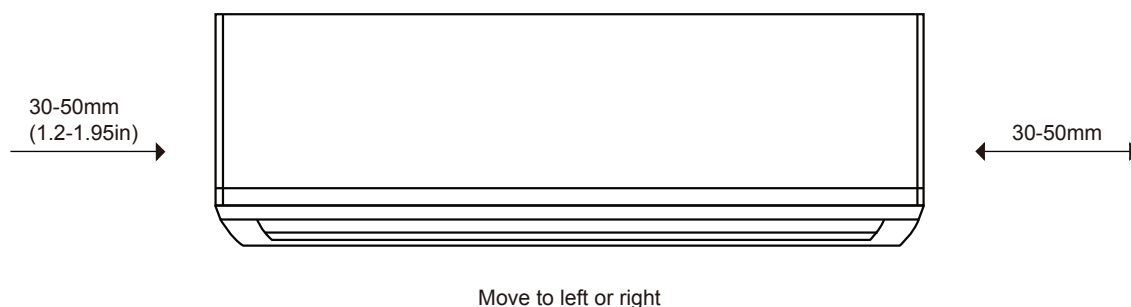

Fig. 4.13

5. Outdoor Unit Installation

5.1 Select installation location

Before installing the outdoor unit, you must choose an appropriate location. The following are standards that will help you choose an appropriate location for the unit.

Proper installation locations meet the following standards:

1. Meets all spatial requirements shown in Installation Space Requirements (Fig. 5.1)
2. Good air circulation and ventilation
3. Firm and solid—the location can support the unit and will not vibrate
4. Noise from the unit will not disturb others
5. Protected from prolonged periods of direct sunlight or rain

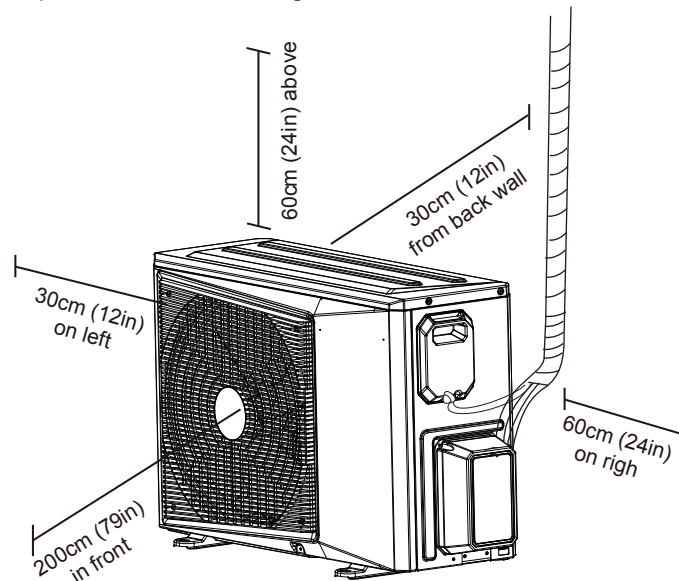

Fig. 5.1

Do not install unit in the following locations:

1. Near an obstacle that will block air inlets and outlets
2. Near a public street, crowded areas, or where noise from the unit will disturb others
3. Near animals or plants that will be harmed by hot air discharge
4. Near any source of combustible gas
5. In a location that is exposed to large amounts of dust
6. In a location exposed to excessive amounts of salty air

Special considerations for extreme weather

1. If the unit is exposed to heavy wind:

Install unit so that air outlet fan is at a 90° angle to the direction of the wind. If needed, build a barrier in front of the unit to protect it from extremely heavy winds.

See Fig. 5.2 and Fig. 5.3 below.

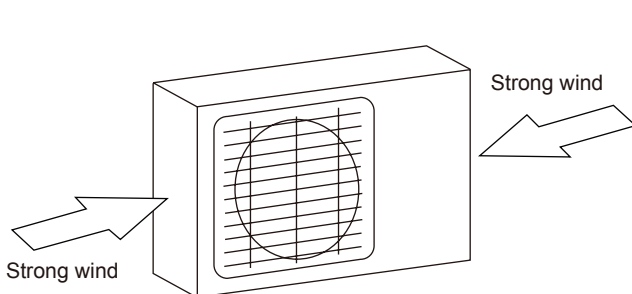

Fig. 5.2

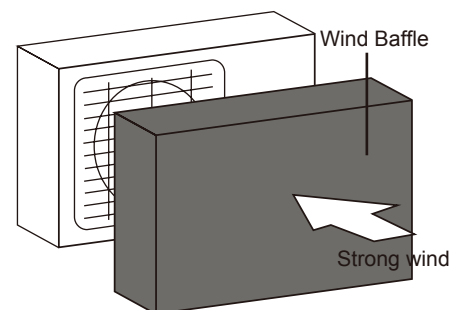

Fig. 5.3

5. Outdoor Unit Installation

2. If the unit is frequently exposed to heavy rain or snow:
Build a shelter above the unit to protect it from the rain or snow. Be careful not to obstruct air flow around the unit.
3. If the unit is frequently exposed to salty air (seaside):
Use outdoor unit that is specially designed to resist corrosion.

5.2 Install drain joint

Heat pump units require a drain joint. Before bolting the outdoor unit in place, you must install the drain joint at the bottom of the unit.

1. Insert the drain joint into the hole in the base pan of the unit.
The drain joint will click in place.
2. Connect a drain hose extension (not included) to the drain joint to redirect water from the unit during heating mode.



Caution

In cold climates, make sure that the drain hose is as vertical as possible to ensure swift water drainage. If water drains too slowly, it can freeze in the hose and flood the unit.

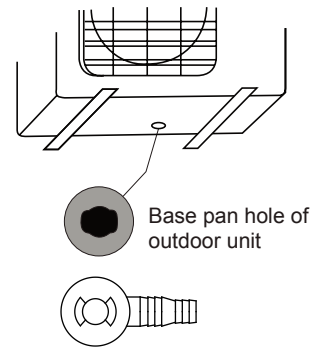

Fig. 5.4

5.3 Anchor outdoor unit

The outdoor unit can be anchored to the ground or to a wall-mounted bracket.

Unit mounting dimensions

The following is a list of different outdoor unit sizes and the distance between their mounting feet. Prepare the installation base of the unit according to the dimensions below.

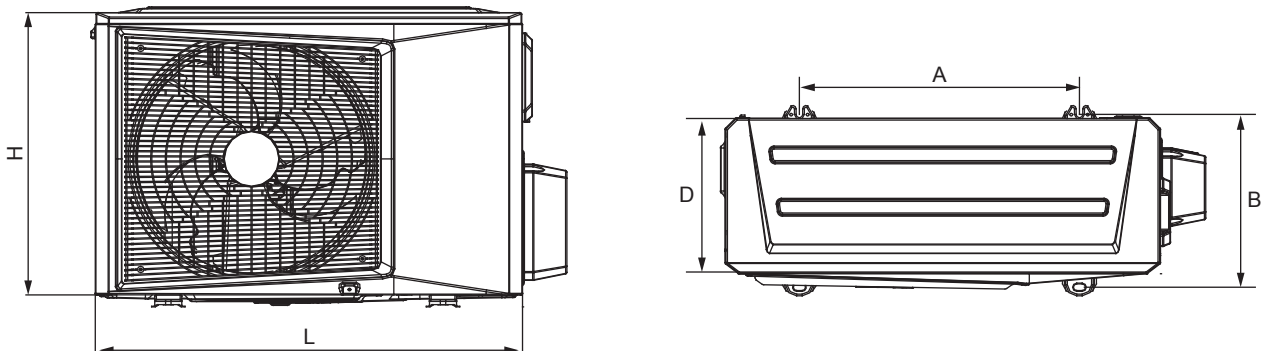

Fig. 5.5

Outdoor Unit Dimensions(mm) L×H×D	Mounting Dimensions	
	Distance A (mm)	Distance B (mm)
735x475x250	453	280
790x520x280	508	314
848x670x354	544	354

5. Outdoor Unit Installation

If you will install the unit on the ground or on a concrete mounting platform, do the following:

1. Mark the positions for four expansion bolts based on dimensions in the Unit Mounting Dimensions chart.
2. Pre-drill holes for expansion bolts.
3. Clean concrete dust away from holes.
4. Place a nut on the end of each expansion bolt.
5. Hammer expansion bolts into the pre-drilled holes.
6. Remove the nuts from expansion bolts, and place outdoor unit on bolts.
7. Put washer on each expansion bolt, then replace the nuts.
8. Using a wrench, tighten each nut until snug.



Warning

When drilling into concrete, eye protection is recommended at all times.

If you will install the unit on a wall-mounted bracket, do the following:

1. Mark the position of bracket holes based on dimensions in the Unit Mounting Dimensions chart.
2. Pre-drill the holes for the expansion bolts.
3. Clean dust and debris away from holes.
4. Place a washer and nut on the end of each expansion bolt.
5. Thread expansion bolts through holes in mounting brackets, put mounting brackets in position, and hammer expansion bolts into the wall.
6. Check that the mounting brackets are level.
7. Carefully lift unit and place its mounting feet on brackets.
8. Bolt the unit firmly to the brackets.

Note:

If allowed, you can install the wall-mounted unit with rubber gaskets to reduce vibrations and noise.



Caution

Before installing a wall-mounted unit, make sure that the wall is made of solid brick, concrete, or of similarly strong material. The wall must be able to support at least four times the weight of the unit.

5.4 Connect signal and power cables

The outside unit's terminal block is protected by an electrical wiring cover on the side of the unit. A comprehensive wiring diagram is printed on the inside of the wiring cover.



Warning

Before performing electrical work, read these regulations

- All wiring must comply with local and national electrical codes, and must be installed by a licensed electrician.
- All electrical connections must be made according to the Electrical Connection Diagram located on the panels of the indoor and outdoor units.
- If there is a serious safety issue with the power supply, stop work immediately. Explain your reasoning to the client, and refuse to install the unit until the safety issue is properly resolved.
- Power voltage should be within 90-110% of rated voltage. Insufficient power supply can cause malfunction, electrical shock, or fire.
- If connecting power to fixed wiring, install a surge protector and main power switch with a capacity of 1.5 times the maximum current of the unit.
- If connecting power to fixed wiring, a switch or circuit breaker that disconnects all poles and has a contact separation of at least 1/8in (3mm) must be incorporated in the fixed wiring. The qualified technician must use an approved circuit breaker or switch.
- Only connect the unit to an individual branch circuit outlet. Do not connect another appliance to that outlet.
- Make sure to properly ground the air conditioner.
- Every wire must be firmly connected. Loose wiring can cause the terminal to overheat, resulting in product malfunction and possible fire.

5. Outdoor Unit Installation

- Do not let wires touch or rest against refrigerant tubing, the compressor, or any moving parts with the unit.
- If the unit has an auxiliary electric heater, it must be installed at least 1 meter (40in) away from any combustible materials.

Warning

Before performing any electrical or wiring work, turn off the main power to the system.

1. Prepare the cable for connection:

Use the right cable

- Indoor Power Cable (if applicable): H05VV-F or H05V2V2-F
- Outdoor Power Cable: H07RN-F
- Signal Cable: H07RN-F

Minimum Cross-Sectional Area of Power and Signal Cables

Rated Current of Appliance (A)	Nominal Cross-Sectional Area (mm ²)
> 3 and ≤ 6	0.75
> 6 and ≤ 10	1
> 10 and ≤ 16	1.5
> 16 and ≤ 25	2.5
> 25 and ≤ 32	4
> 32 and ≤ 40	6

- Using wire strippers, strip the rubber jacket from both ends of signal cable to reveal about 40mm (1.57in) of the wires inside.
- Strip the insulation from the ends of the wires.
- Using wire crimper, crimp u-type lugs on the ends of the wires.

Note: While crimping wires, make sure you clearly distinguish the Live (“L”) Wire from other wires.

Warning

All wiring must be performed strictly in accordance with the wiring diagram located on the inside of the outdoor unit's wire cover.

- Unscrew the electrical wiring cover and remove it.
- Unscrew the cable clamp below the terminal block and place it to the side.
- Match the wire colors/labels with the labels on the terminal block, and firmly screw the u-lug of each wire to its corresponding terminal.
- After checking to make sure every connection is secure, loop the wires around to prevent rain water from flowing into the terminal.
- Using the cable clamp, fasten the cable to the unit. Screw the cable clamp down tightly.
- Insulate unused wires with PVC electrical tape.
Arrange them so that they do not touch any electrical or metal parts.
- Replace the wire cover on the side of the unit, and screw it in place.

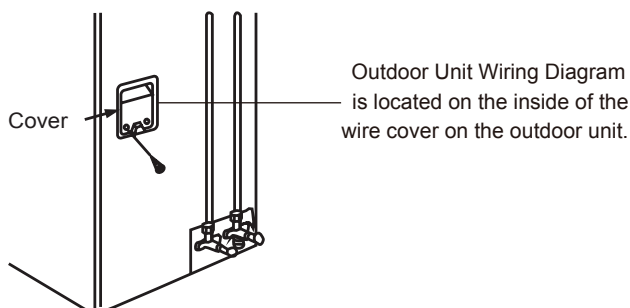

6. Refrigerant Piping Connection

6.1 Note on Pipe Length

The length of refrigerant piping will affect the performance and energy efficiency of the unit. Nominal efficiency is tested on units with a pipe length of 5 meters (16.5ft). A minimum pipe run of 3 meters is required to minimise vibration & excessive noise.

Refer to the table below for specifications on the maximum length and drop height of piping.

Maximum Length and Drop Height of Refrigerant Piping per Unit Model

Model	Capacity (BTU/h)	Max. Length (m)	Max. Drop Height (m)
R410A & R32 Inverter Split Air Conditioner	< 15,000	25 (82ft)	10 (33ft)
	15,000 and < 24,000	30 (98.5ft)	20 (66ft)
	24,000 and < 36,000	50 (164ft)	25 (82ft)
R410A & R32 Fixed-speed Split Air Conditioner	< 18,000	20 (66ft)	8(26ft)
	18,000 and < 36,000	25 (82ft)	10(33ft)

6.2 Refrigerant Piping Connection Instruction

1. Cut Pipes

When preparing refrigerant pipes, take extra care to cut and flare them properly. This will ensure efficient operation and minimize the need for future maintenance.

- 1) Measure the distance between the indoor and outdoor units.
- 2) Using a pipe cutter, cut the pipe a little longer than the measured distance.
- 3) Make sure that the pipe is cut at a perfect 90° angle. Refer to Fig. 6.1 for bad cut examples.

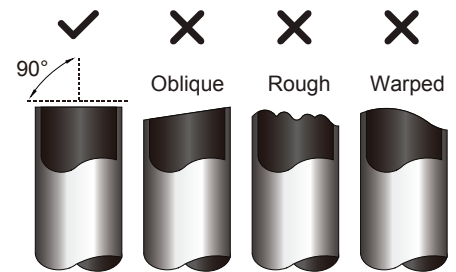

Fig. 6.1

! Caution

Be extra careful not to damage, dent, or deform the pipe while cutting. This will drastically reduce the heating efficiency of the unit.

2. Remove burrs

Burrs can affect the air-tight seal of refrigerant piping connection. They must be completely removed.

- 1) Hold the pipe at a downward angle to prevent burrs from falling into the pipe.
- 2) Using a reamer or deburring tool, remove all burrs from the cut section of the pipe.

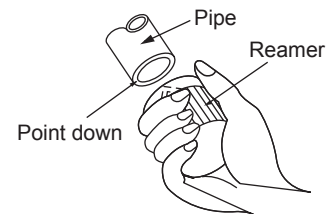

Fig. 6.2

3. Flare pipe ends

Proper flaring is essential to achieve an airtight seal.

- 1) After removing burrs from cut pipe, seal the ends with PVC tape to prevent foreign materials from entering the pipe.
- 2) Sheath the pipe with insulating material.
- 3) Place flare nuts on both ends of pipe. Make sure they are facing in the right direction, because you can't put them on or change their direction after flaring. See Fig. 6.3.
- 4) Remove PVC tape from ends of pipe when ready to perform flaring work.

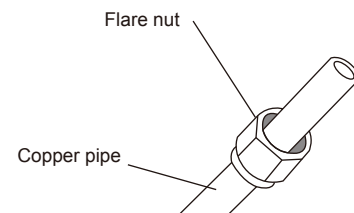

Fig. 6.3

6. Refrigerant Piping Connection

5) Clamp flare form on the end of the pipe.

The end of the pipe must extend beyond the edge of the flare form in accordance with the dimensions shown in the table below.

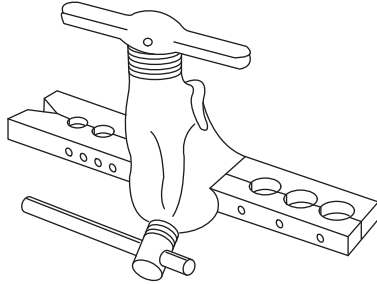

Fig. 6.4

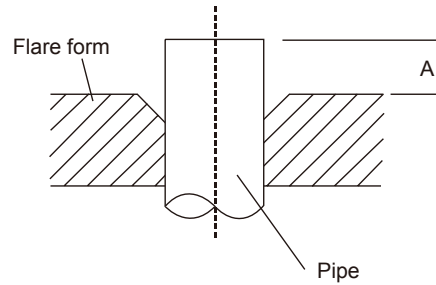

Fig. 6.5

Piping Extension Beyond Flare Form

Outer Diameter of Pipe (mm)	A(mm)	
	Min.	Max,
ϕ 6.35 (ϕ 0.25")	0.7 (0.0275")	1.3 (0.05")
ϕ 9.52 (ϕ 0.375")	1.0 (0.04")	1.6 (0.063")
ϕ 12.7 (ϕ 0.5")	1.0 (0.04")	1.8 (0.07")

6) Place flaring tool onto the form.

7) Turn the handle of the flaring tool clockwise until the pipe is fully flared.

8) Remove the flaring tool and flare form, then inspect the end of the pipe for cracks and even flaring.

4. Connect pipes

When connecting refrigerant pipes, be careful not to use excessive torque or to deform the piping in any way. You should first connect the low-pressure pipe, then the high-pressure pipe.

Minimum Bend Radius

When bending connective refrigerant piping, the minimum bending radius is 10cm. See Fig.6.6.

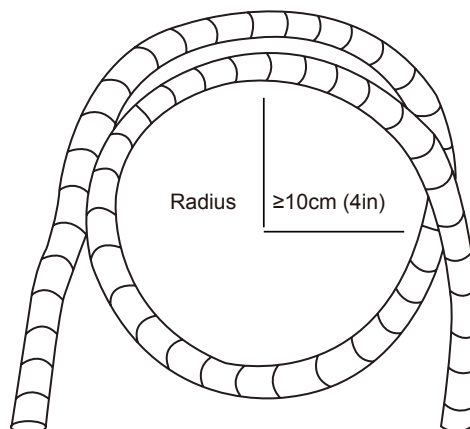

Fig. 6.6

6. Refrigerant Piping Connection

6.3 Instructions for Connecting Piping to Indoor Unit

1. Align the center of the two pipes that you will connect. See Fig.6.7.

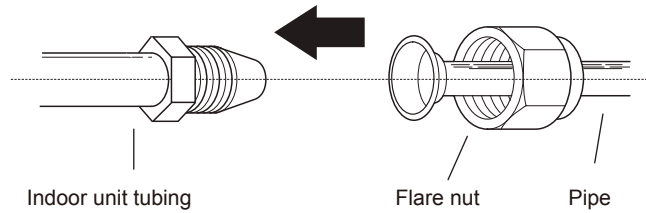

Fig. 6.7

2. Tighten the flare nut as tightly as possible by hand.
3. Using a spanner, grip the nut on the unit tubing.
4. While firmly gripping the nut on the unit tubing, use a torque wrench to tighten the flare nut according to the torque values in the Torque Requirements table below. Loosen the flaring nut slightly, then tighten again.

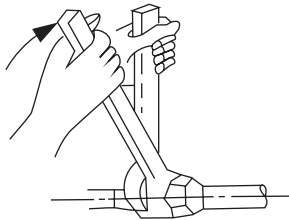

Fig. 6.8

Torque Requirements

Outer Diameter of Pipe (mm)	Tightening Torque (N•cm)	Add. Tightening Torque (N•cm)
φ 6.35 (φ 0.25")	1,500 (11lb•ft)	1,600 (11.8lb•ft)
φ 9.52 (φ 0.375")	2,500 (18.4lb•ft)	2,600 (19.18lb•ft)
φ 12.7 (φ 0.5")	3,500 (25.8lb•ft)	3,600 (26.55lb•ft)



Caution

Excessive force can break the nut or damage the refrigerant piping. You must not exceed torque requirements shown in the table above.

6. Refrigerant Piping Connection

6.4 Instructions for Connecting Piping to Outdoor Unit

1. Unscrew the cover from the packed valve on the side of the outdoor unit. (See Fig. 6.9)

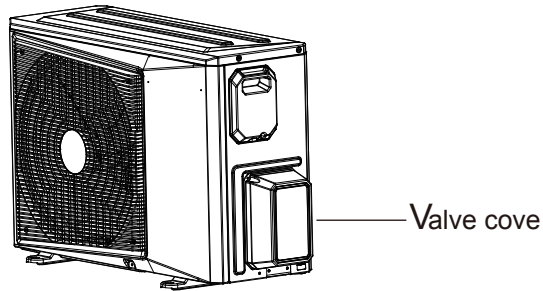

Fig. 6.8

2. Remove protective caps from ends of valves.
3. Align flared pipe end with each valve, and tighten the flare nut as tightly as possible by hand.
4. Using a spanner, grip the body of the valve. Do not grip the nut that seals the service valve. (See Fig. 5.10)

! **Caution**

Use spanner to grip main body of valve

Torque from tightening the flare nut can snap off other parts of valve.

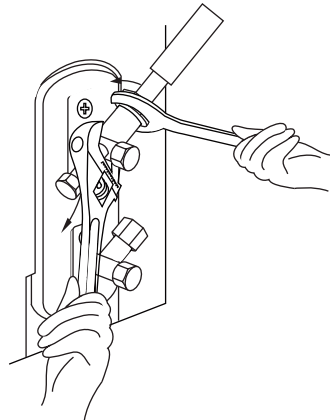

Fig. 6.9

5. While firmly gripping the body of the valve, use a torque wrench to tighten the flare nut according to the correct torque values.
6. Loosen the flaring nut slightly, then tighten again.
7. Repeat Steps 3 to 6 for the remaining pipe.

7. Air Evacuation

7.1 Preparations and Precautions

Air and foreign matter in the refrigerant circuit can cause abnormal rises in pressure, which can damage the air conditioner, reduce its efficiency, and cause injury. Use a vacuum pump and manifold gauge to evacuate the refrigerant circuit, removing any non-condensable gas and moisture from the system.

Evacuation should be performed upon initial installation and when unit is relocated.

Before Performing evacuation

1. Check to make sure that both high-pressure and low-pressure pipes between the indoor and outdoor units are connected properly in accordance with the Refrigerant Piping Connection section of this manual.
2. Check to make sure all wiring is connected properly.

7.2 Evacuation Instructions

Before using the manifold gauge and vacuum pump, read their operation manuals to familiarize yourself with how to use them properly.

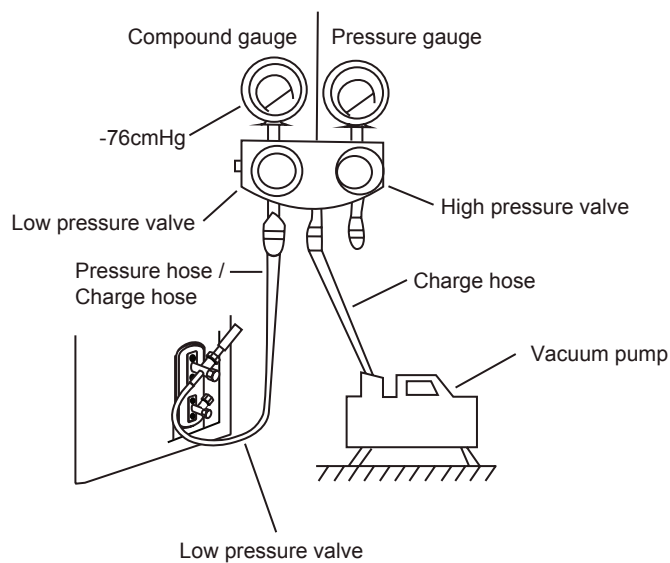
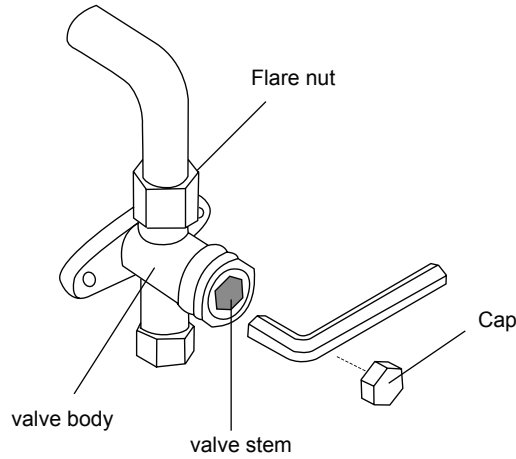

Fig. 7.1

1. Connect the charge hose of the manifold gauge to service port on the outdoor unit's low pressure valve.
2. Connect another charge hose from the manifold gauge to the vacuum pump.
3. Open the Low Pressure side of the manifold gauge. Keep the High Pressure side closed.
4. Turn on the vacuum pump to evacuate the system.
5. Run the vacuum for at least 15 minutes, or until the Compound Meter reads -76cmHG (-10⁵ Pa).
6. Close the Low Pressure side of the manifold gauge, and turn off the vacuum pump.
7. Wait for 5 minutes, then check that there has been no change in system pressure.
8. If there is a change in system pressure, refer to Gas Leak Check section for information on how to check for leaks. If there is no change in system pressure, unscrew the cap from the packed valve (high pressure valve).
9. Insert hexagonal wrench into the packed valve (high pressure valve) and open the valve by turning the wrench in a 1/4 counterclockwise turn. Listen for gas to exit the system, then close the valve after 5 seconds.
10. Watch the Pressure Gauge for one minute to make sure that there is no change in pressure. The Pressure Gauge should read slightly higher than atmospheric pressure.
11. Remove the charge hose from the service port.
12. Using hexagonal wrench, fully open both the high pressure and low pressure valves.
13. Tighten valve caps on all three valves (service port, high pressure, low pressure) by hand. You may tighten it further using a torque wrench if needed.

7. Air Evacuation



! Caution

Open valve stems gently

When opening valve stems, turn the hexagonal wrench until it hits against the stopper. Do not try to force the valve to open further.

7.3 Note on Adding Refrigerant

Some systems require additional charging depending on pipe lengths. The standard pipe length varies according to local regulations. The standard pipe length is 5m (16'). The additional refrigerant to be charged can be calculated using the following formula:

Additional Refrigerant per Pipe Length

Connective Pipe Length (m)	Air Purging Method	Additional Refrigerant	
≤ Standard pipe length	Vacuum Pump	N/A	
> Standard pipe length	Vacuum Pump	Liquid Side: φ 6.35 Inverter R410A & R32: (Pipe length – standard length) x 15g/m Fixed-frequency R410A & R32: (Pipe length – standard length) x 15g/m	Liquid Side: φ 9.52 Inverter R410A & R32: (Pipe length – standard length) x 30g/m Fixed-frequency R410A & R32: (Pipe length – standard length) x 30g/m

! Caution

Do not mix refrigerant types.

8. Methods of Maintenance

The air conditioner must be turned off and plug pulled out before the maintenance is to be carried out.

8.1 Before the season of operation

1. Check if there are any blocking materials in the intake and outlet vents of the indoor and outdoor units.
2. Check if the installation stand is corroded or rusty.
3. Check if the machine is properly grounded.
4. Check if the air filter is clean.
5. Connect to the power source.
6. Put batteries in the remote controller.

8.2 During the season of operation

The cleaning of the air filter screen(standard intervals should be once every two weeks).

1. Remove the air filter screen from the unit.
 - Gently press the two lower ends of the grid and open it.
 - Gently pull up the air filter screen and take it out in the direction of your body.
2. Clean the air filter screen.

if the screen is very dirty, please use lukewarm water (about 30°C or 86°F to clean it. Air it dry after the cleaning.

Note:

 - Do not use boiling water to clean the screen.
 - Do not bake the screen dry over a fire.
 - Do not exert too much force in pulling and stretching the screen.
3. Install the air filter screen.

To operate the air conditioner without the air filter screen on will cause the interior of the machine dirty which might lead to poor performances or damages to the units.
4. Clean the air conditioner
 - Use a soft and dry cloth to rub the air conditioner, or use a vacuum cleaner to clean it.
 - If the air conditioner is very dirty, use a piece of cloth and soak it with neutral home-use detergent to do the cleaning.

8.3 After the season of operation

1. Set the temperature at 30°C or 86°F and operate in the fan status for about half a day to make the interior the units dry.
2. Stop the operation of the machine and turn off the power switch .

The air conditioner will consume about 5W of electric power after the machine is turned off, For the purpose of energy saving and safety, it is advisable to pull the plug out during the non-operational seasons.
3. Clean and install the air filter screen.
4. Clean the indoor and outdoor units.
5. Take the batteries out from the remote controller.

Note:

If the air filter screen is blocked by dust or dirt, the performance of cooling and heating will be affected, with the operation noise and power consumption increased. Therefore, the air filter screen should be cleaned regularly.

9. Phenomenon Analysis and Treatment measures

9.1 Self-analysis

Please check the following before requesting after-sale service from your dealer.

1. When the air conditioner does not operate at all.
 - 1) Is the power plug in an outlet?
 - 2) Is the time set to "ON" position?
 - 3) Is there a power failure or a blown fuse?
2. When poor cooling or heating performance.
 - 1) Is the room temperature setting suitable?
 - 2) Are the air filters clean (Not clogged)?
 - 3) Are the window(s) and door(s) opened?
3. When poor cooling performance.
 - 1) Is direct sunlight entering the room?
 - 2) Is there a heat source in the room?
 - 3) Are there too many people in the room?

9.2 Contact with distributor Immediately

Pull out the power plug immediately and inform to your distributor in the following situations:

1. Fuse or breaker often breaks off.
2. Power plug or code is excessively hot.
3. Covering of power plug or code is broken.
4. Malfunction is observed TV, radio or other devices.
5. Switch does not actuate surely.
6. Abnormal noise is heard during operation.

When faulty operation movement is observed when the RUN button is pressed, even after pulling out the power plug and restarting the operation after 3 minutes, faulty movement does not disappear.

9.3 Phenomenons what user need to know

We hope you will know the following when using the unit.

Phenomenons	Reasons
The unit can not be restarted just after shut down. (RUN lamp is illuminating)	Restart is stopped for 3 minutes after shut down to protect the unit. Three-minute protection timer incorporated in the microcomputer actuates automatically. Except that power is connected, this function does not actuate.
Air is not blown out at starting of heating operation.	Air blow is stopped to prevent blowing out of cold air until the indoor heat exchanger is warmed. (2 to 5 min) (Hot Keep)
The unit will not stop blowing out the air immediately after shut down at COOL operation (some model)	Because the unit is doing mould proofing operation and indoor fan motor runs at low speed. The louver will not close down until after 30 seconds.
Air is not blown out for 6 to 12 min, at heating operation.	When outdoor temperature is low and humidity is high, the unit sometimes performs defrosting automatically. Please wait. During defrosting, water or steam are raising from the outdoor unit.
Air is not blown out at DRY operation.	Indoor fan is sometimes stopped to prevent vapor of dehumidified moisture and save energy.
Mist is blown out at COOL operation.	This phenomenon sometimes occurs when the temperature and humidity of the room are very high, but it will disappear with lowering of the temperature and humidity.
Odor is sent out.	Air blown out during operation may smell. This is the smell of tobacco or cosmetics stuck to the unit.
Noise is heard cracking sound.	This is caused by the refrigerant that is circulating inside the unit.

9. Phenomenon Analysis and Treatment measures

Continue above table

Noise is heard cracking sound. After a power stoppage or after disconnecting the power supply plug.	This is caused by heat expansion or contraction of plastics.
Operation can not be restarted even if the power is recovered.	The memory circuit of the microcomputer is cleared. Operate the remote controller again to restart the operation.
Remote control signals are not received.	Remote control signals may not be received when signal receiver on the air conditioner body is exposed to direct sunlight or strong lighting. In that case, interrupt the sunlight or darken the lighting.
Moisture may from on the air outlet grilles.	If the unit is operated for a long period of time with the high humidity, moisture may from on the air outlet grilles and drip down.

9.4 Display with Fault

Definitions of malfunction	Contents appearing
Communication failure of indoor and outdoor unit	E1
T1 sensor fault	E2
T2 sensor fault	E3
T2B sensor fault	E4
Malfunction of outdoor unit	E5
Testing fault of zero-crossing signal	E6
EEPROM malfunction	E7
Wind testing fault of PG electric motor	E8
Communication fault of wire controller	E9
Room card is not connected	HC

